

1-20

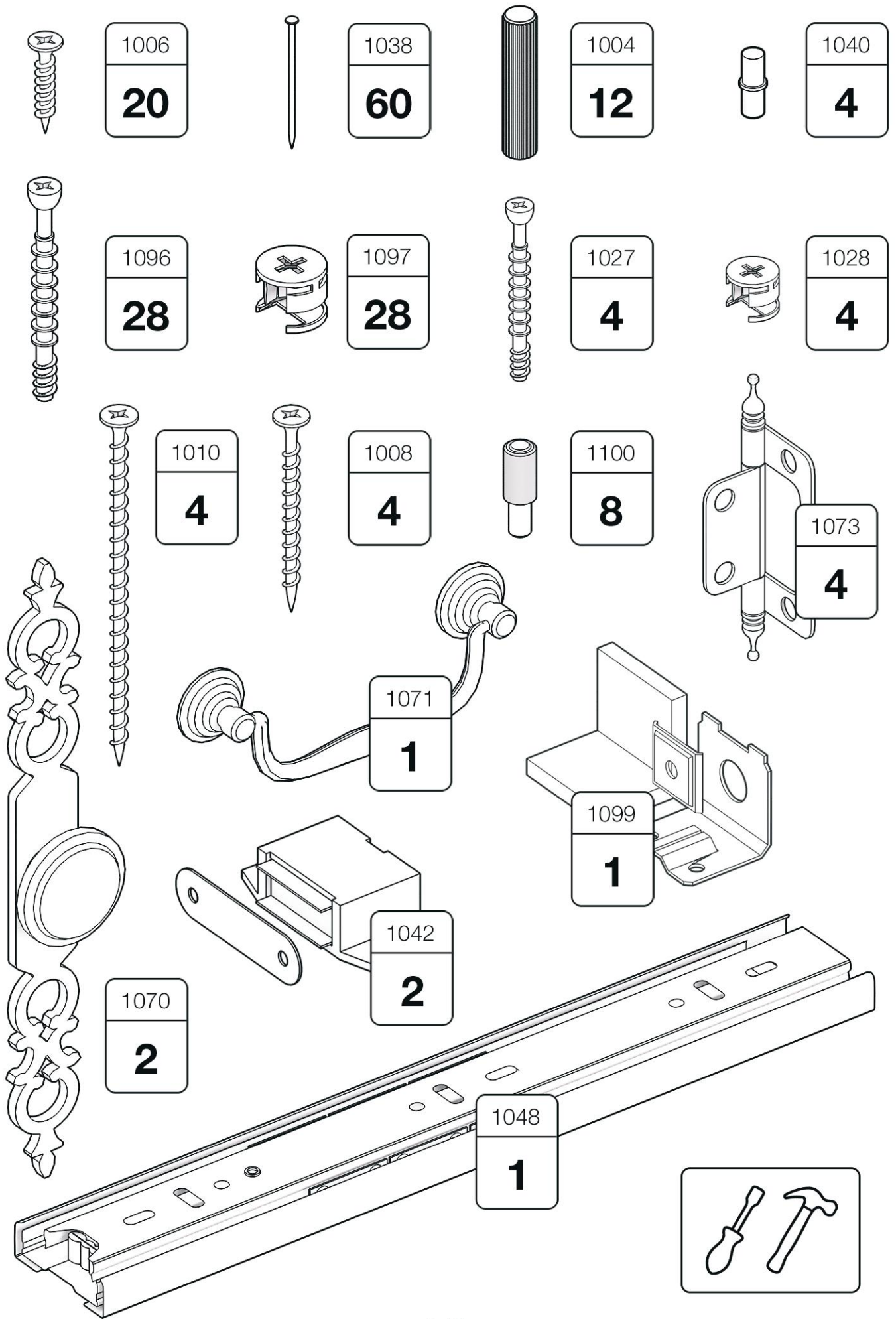

 **TIMBERICA**

- RU** Инструкция по сборке
- EN** Assembly instruction
- FI** Koontaohje



1

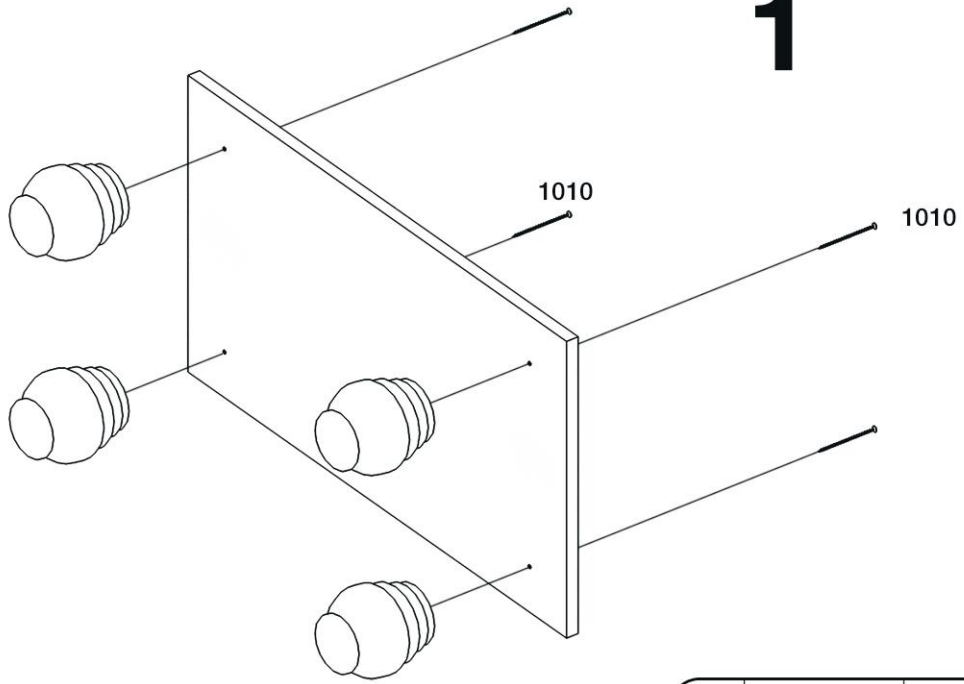

2

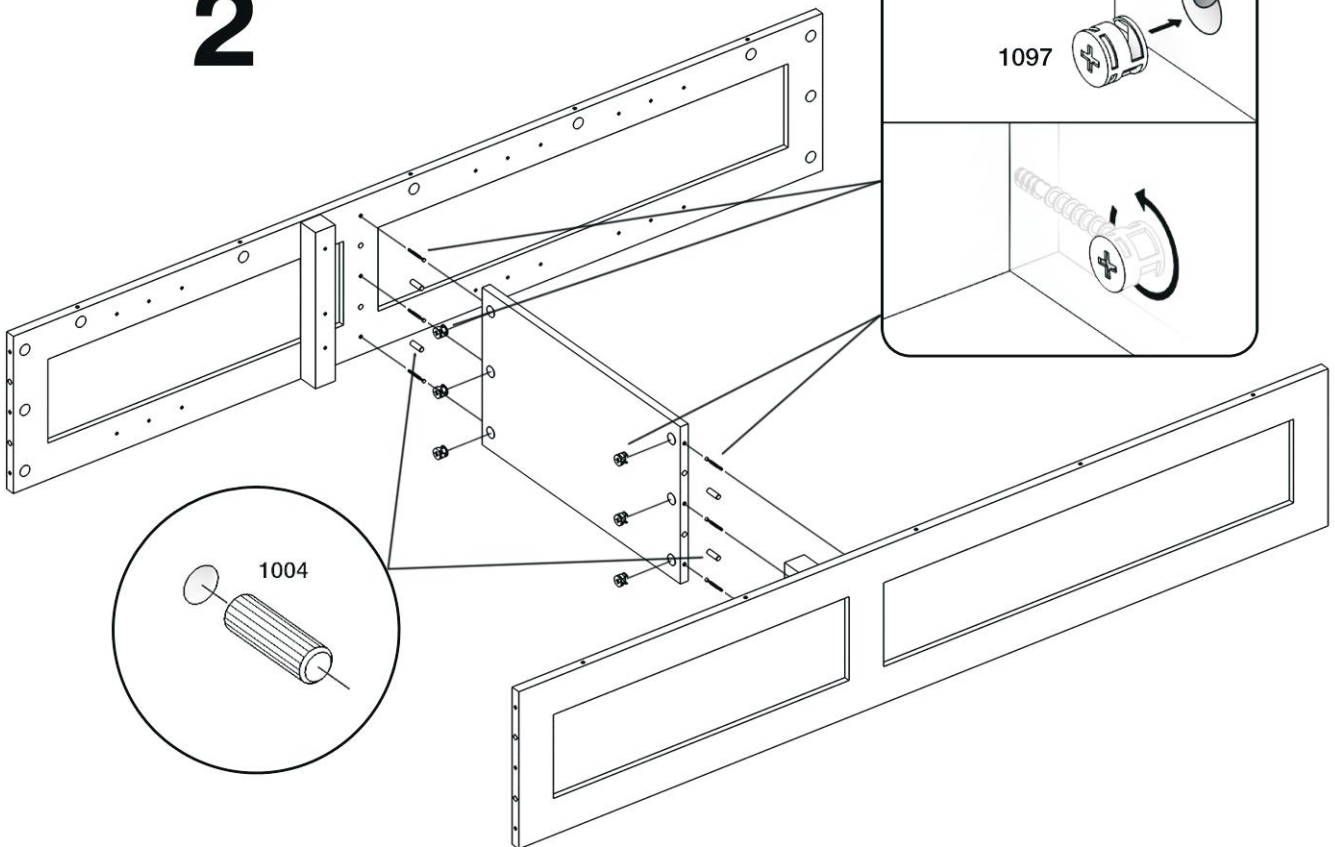

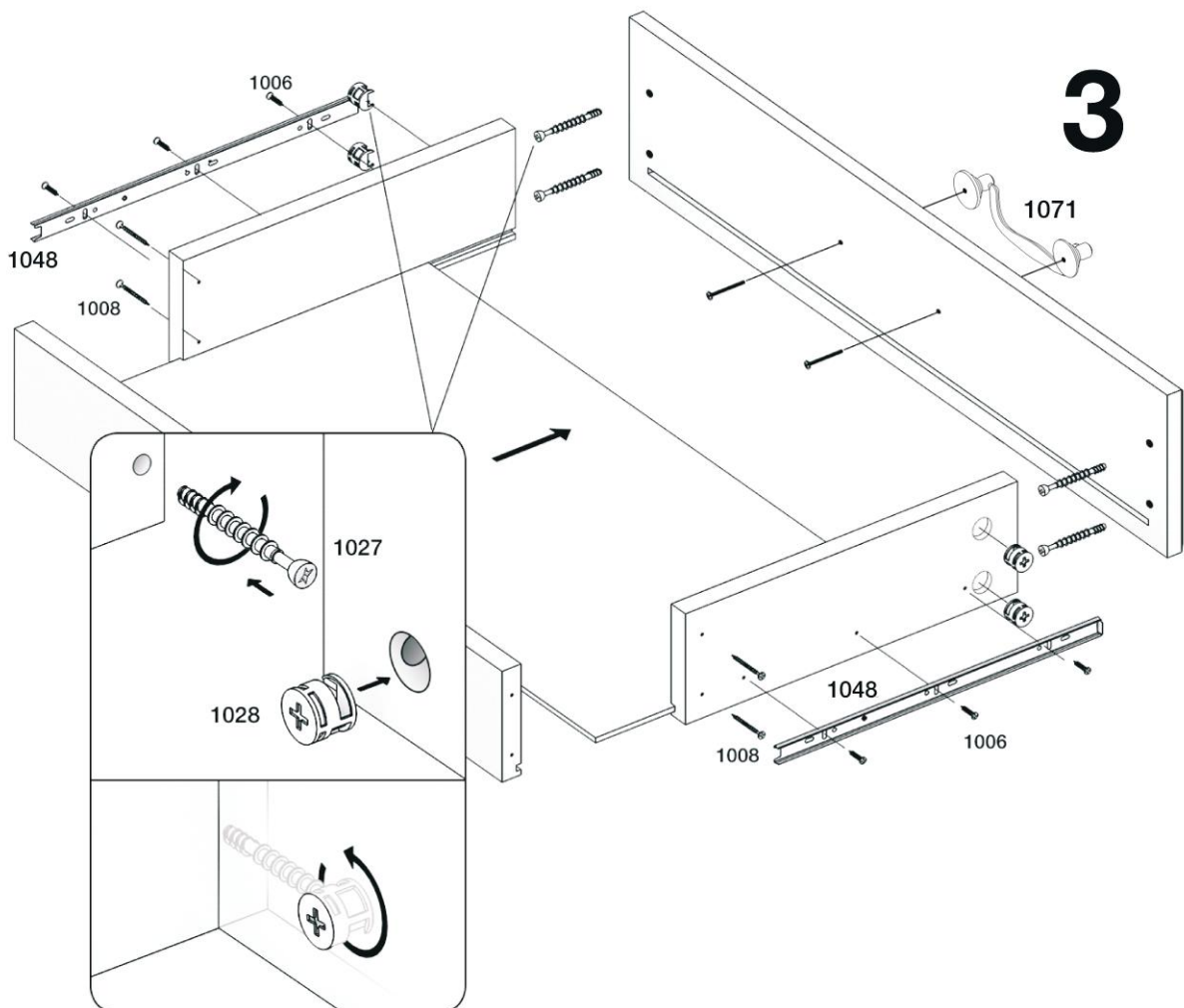
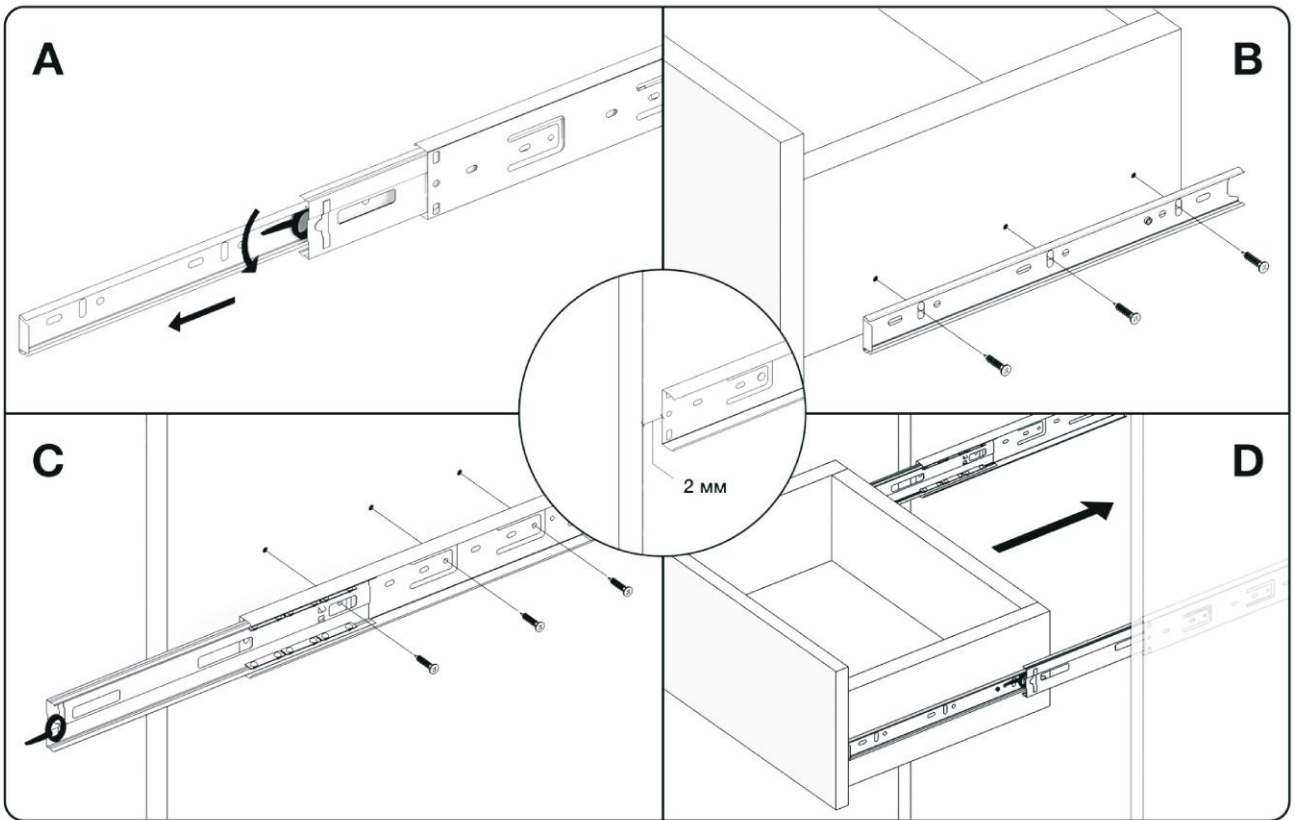

4

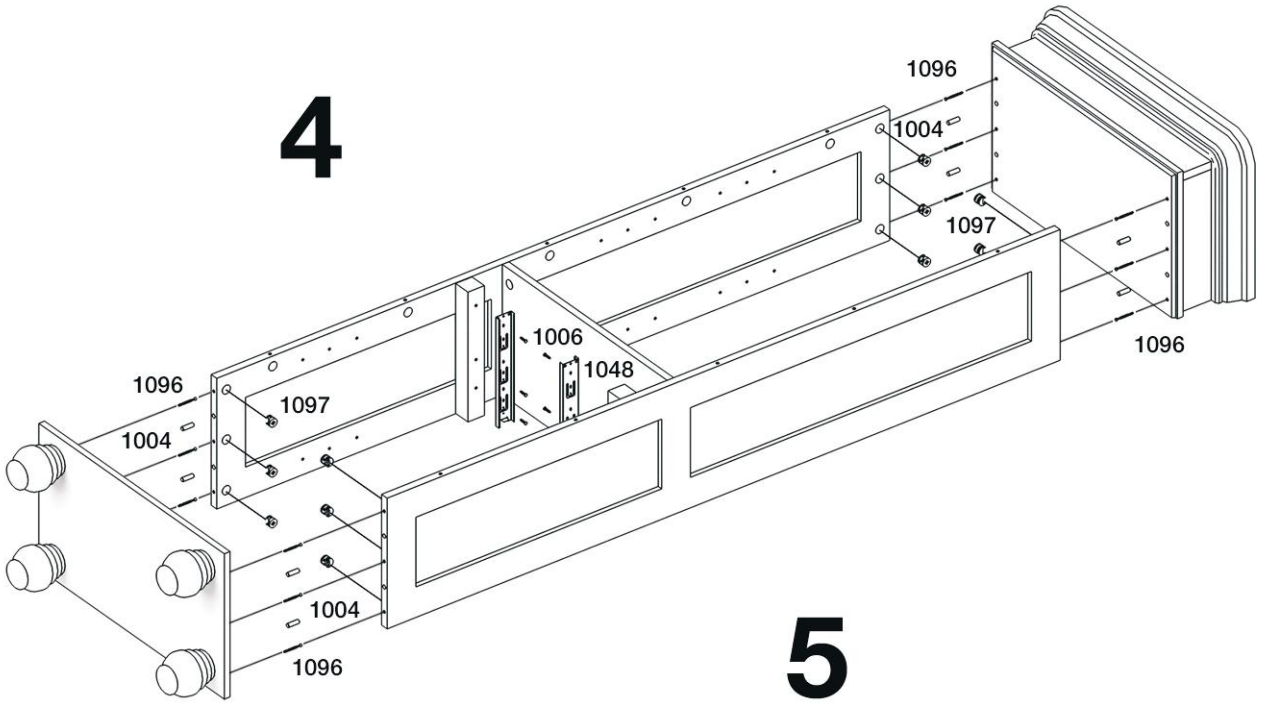

5

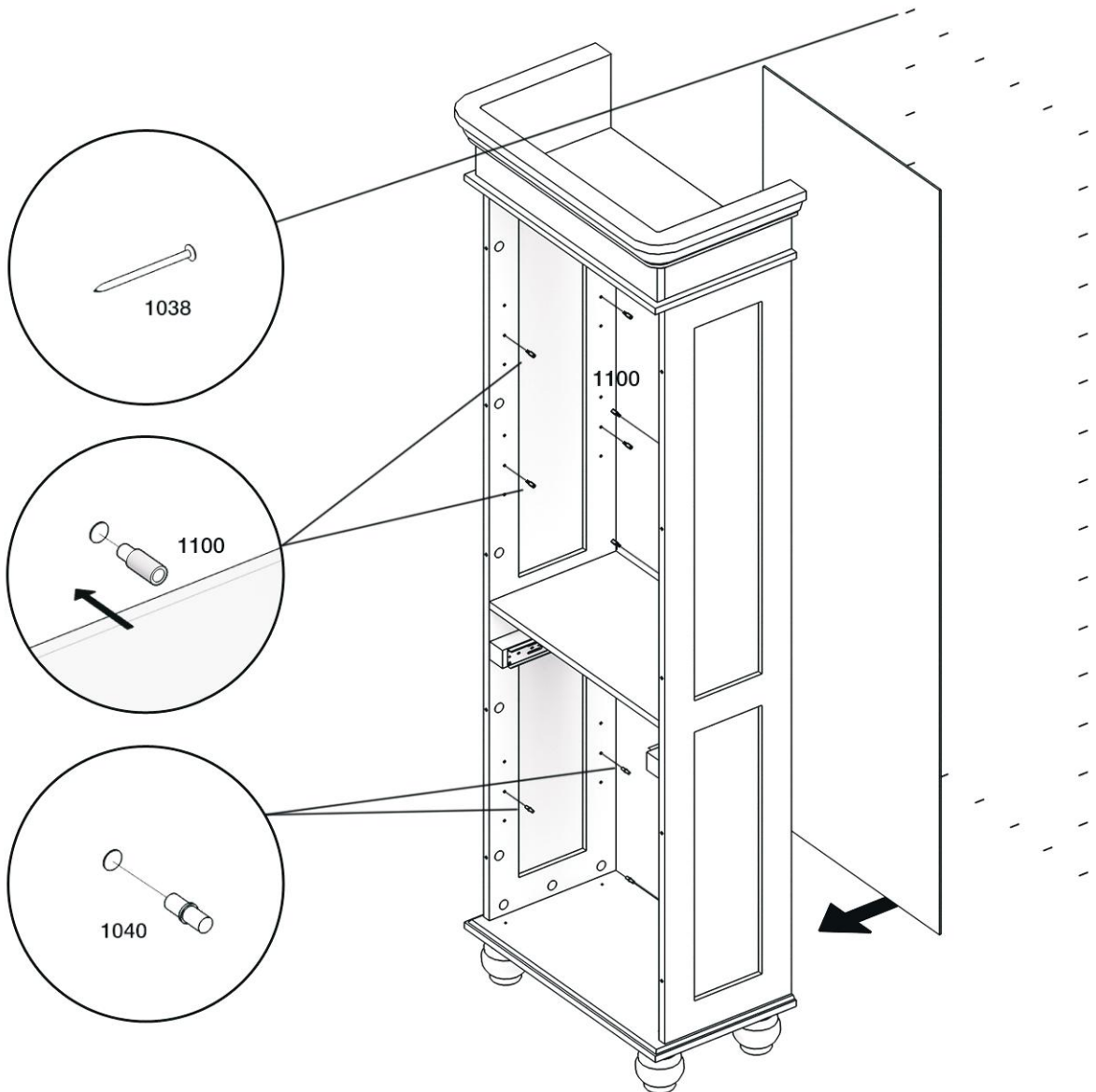

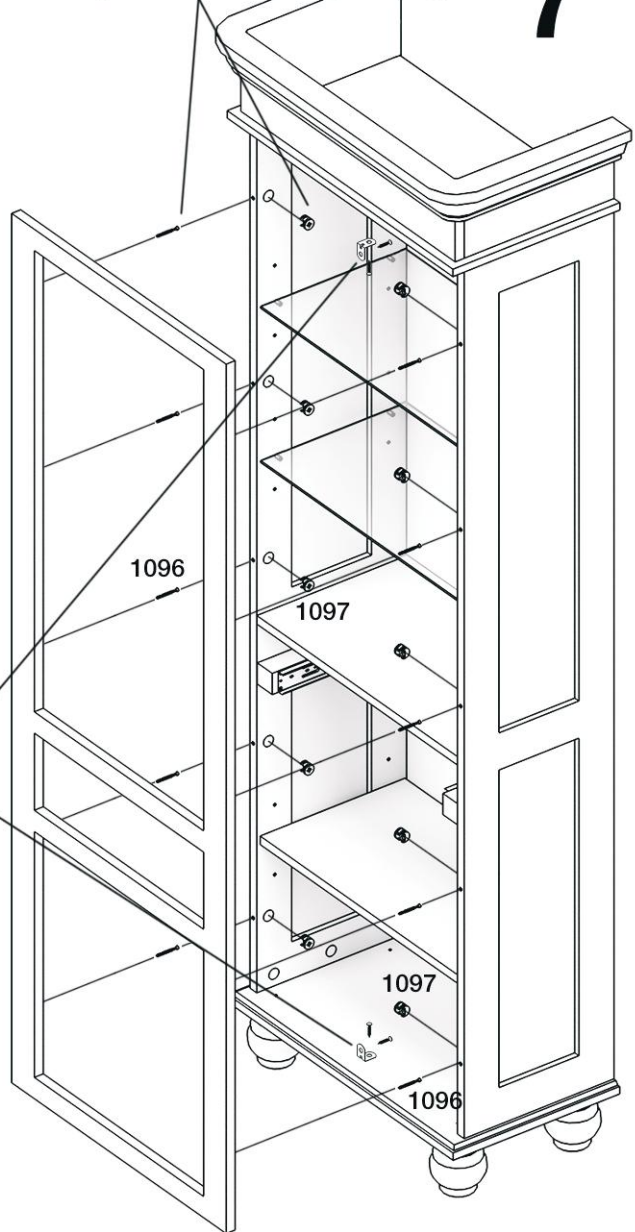
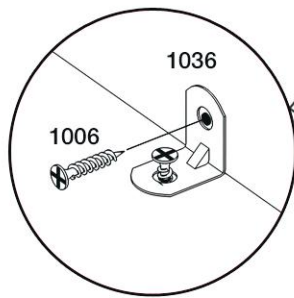
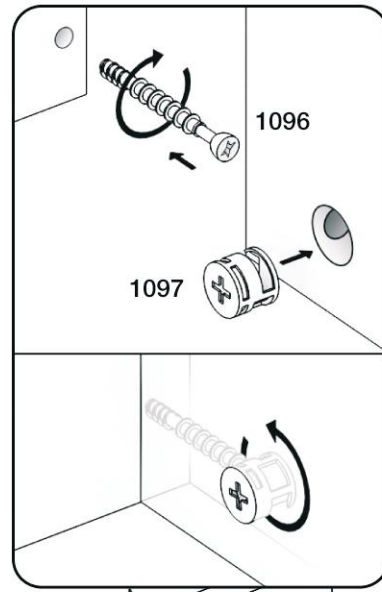
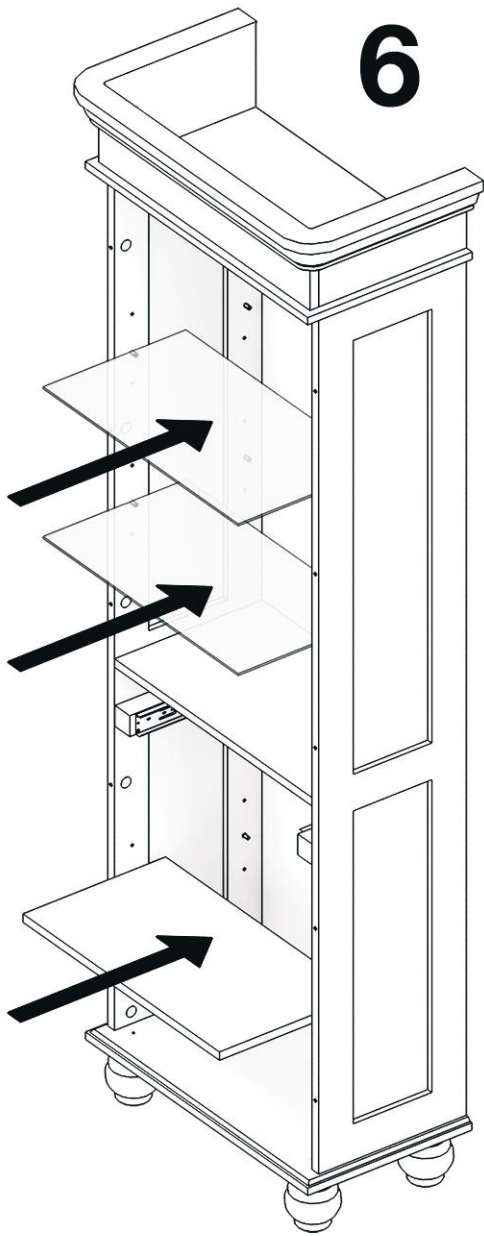

8

