

# Бетти

Шкаф 2-створчатый №5

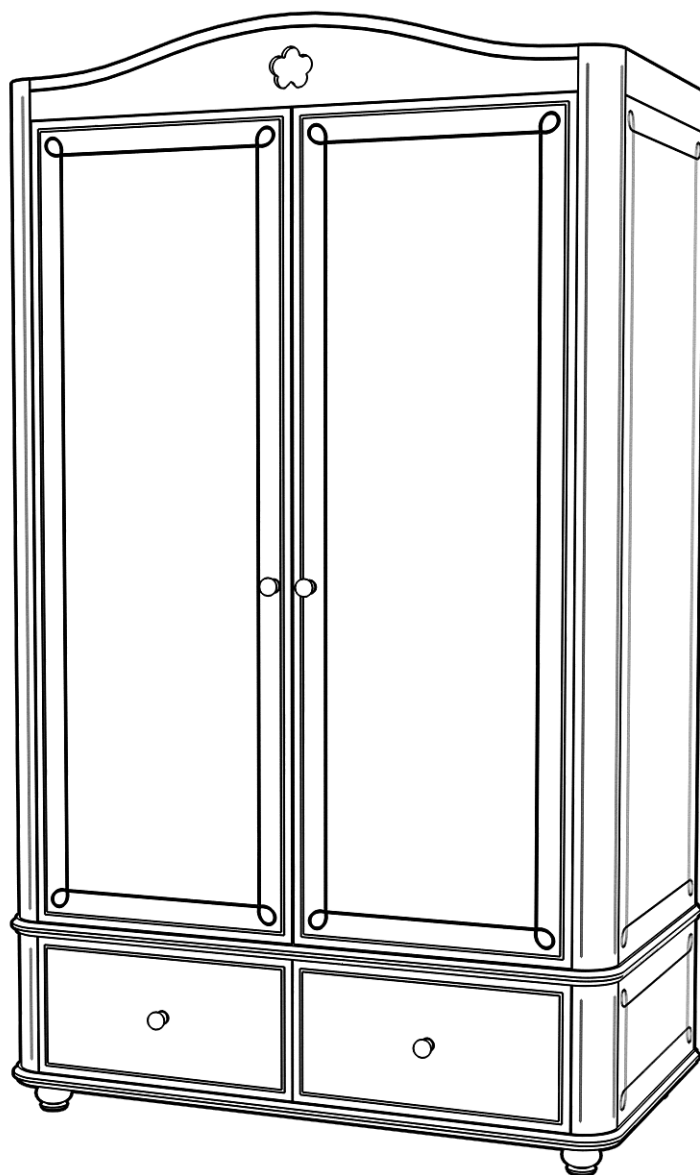

- RU** Инструкция по сборке
- EN** Assembly instruction
- FI** Koontaohje



1028  
**4**



1006  
**70**



1008  
**12**

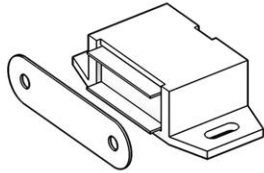

1042  
**2**



1096  
**46**



1097  
**46**

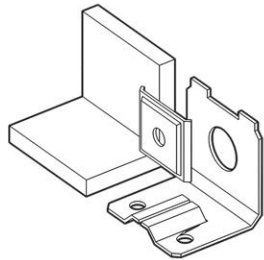

1099  
**2**



1040  
**12**



1038  
**84**

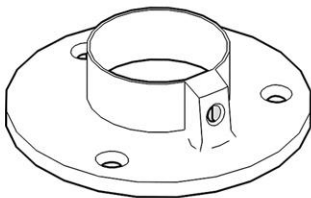

1047  
**2**

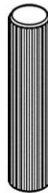

1004  
**26**

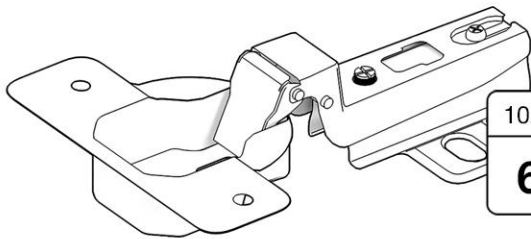

1024  
**6**

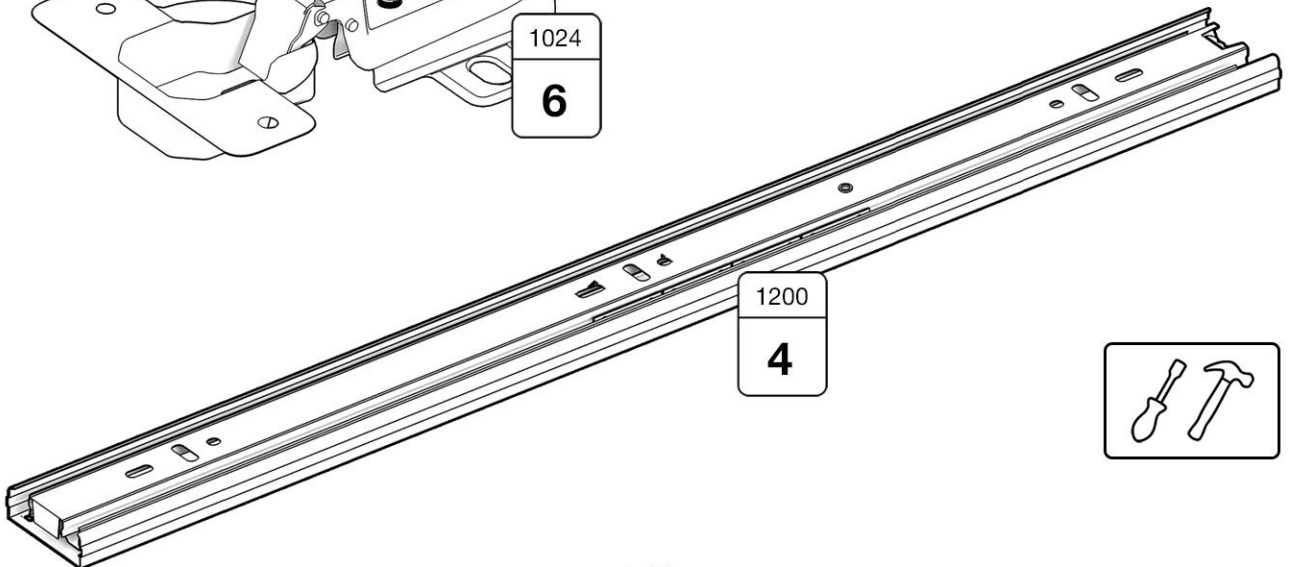

1200  
**4**

